



HARDWARE GUIDE

Humidifier Controller C1050 Series

Specifications and Operational Guide

www.proloncontrols.com | info@proloncontrols.com
17 510, rue Charles, Suite 100, Mirabel, QC, J7J 1X9



Table of Contents

General Information	4
PL-C1050 Humidity Controller.....	4
Description.....	4
General Behaviour.....	4
Operating Sequence	5
Humidification.....	5
Dehumidification.....	5
Components	6
Component Identification.....	6
LEDs	7
Address Configuration for Networking	7
Input and Output Identification.....	8
Inputs	9
Analog Input.....	9
Outside Temperature Sensor	9
Relative Humidity Sensors	10
Proof of Fan.....	10
Outputs	11
Output Specifications	11
Configuration of Outputs 3 and 4	11
Typical Connection of the Triac Outputs 3 and 4.....	12
Typical Connection of the Analog Output	13
Power Source / Network	14
Power Source	14
Network Communication.....	14
Technical Specifications	15
Compliance	16
FCC User Information	16
Industry Canada	16
Overall Dimensions.....	17



Table of Figures

Figure 1 - Component Identification.....	6
Figure 2 - LEDs Identification	7
Figure 3 - Addressing Dipswitches.....	7
Figure 4 - Input and Output Identification.....	8
Figure 5 - Analog input	9
Figure 6 - Connecting the Outside Air Sensor	9
Figure 7 - Connecting the Humidity Sensors.....	10
Figure 8 - Connecting the Proof of Fan	10
Figure 9 - Output in SOURCE mode.....	11
Figure 10 - Output in SINK mode.....	12
Figure 11 - Connection of Active Outputs 3 and 4.....	12
Figure 12 - Connection of Passive Outputs 3 and 4.....	12
Figure 13 - Connecting the Analog Output (Controller Powered)	13
Figure 14 - Connecting the Analog Output (External Power)	13
Figure 15 - Connecting the 24VAC Power Source.....	14
Figure 16 - Connecting to the Network	14
Figure 17 - C1050 Size Diagram	17



PL-C1050 Humidity Controller

Description

The PL-C1050 humidity controller is a microprocessor-based controller designed to regulate the relative humidity level in a room or return duct. Both humidification and dehumidification sequences are available. It features a variety of control strategies, including outdoor temperature reset, unoccupied mode setpoint offsets, safety limits and more.

General Behaviour

Although fully configurable, the Prolon C1050 humidity controller monitors dedicated inputs and uses pre-established control sequences to drive dedicated outputs to control standard humidification or dehumidification equipment. These sequences can be fully optimized to obtain the best results for each type of system. The various configuration options allow the user to modify the outside temperature reset scale, the dehumidification control points, the high humidity limits in the supply and more. A sequence to request fan reactivation in night mode is also available. All these parameters can be accessed and modified by using the Prolon Focus software.

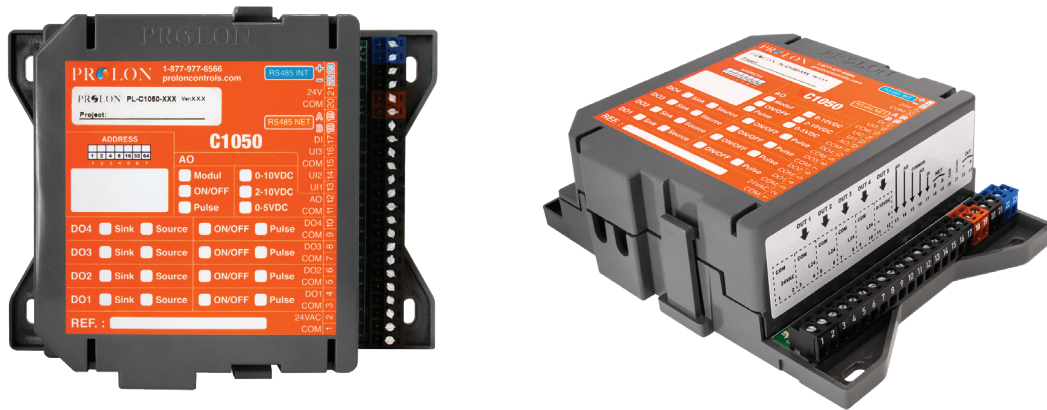



Operating Sequence

Humidification

The C1050 humidity controller obtains an outside air temperature reading from either a connected sensor or transmitted from a network master. The current outside temperature determines the relative humidity setpoint to maintain in the zone or return using a configurable reset scale. Proof of fan operation is required to enable humidification. The C1050 has a dedicated input for the proof of fan, but it can also be transmitted to the C1050 from a network master.

The C1050 has two outputs available for humidification: a digital ON or OFF (differential) triac output and an analog (0-10VDC) modulating or pulsing output, which uses a proportional and integral control loop to maintain the setpoint.

A humidity sensor can optionally be installed in the supply duct, which then enables high humidity limit control. Humidification also stops when the outside temperature becomes too warm.

In unoccupied mode, the C1050 can request that the network master restarts the fan if the humidity gets too low.

Dehumidification

The C1050 request dehumidification when the humidity level goes beyond its user-configurable setpoint. Proof of fan operation is required to enable dehumidification. The C1050 has a dedicated input for the proof of fan, but it can also be transmitted to the C1050 from a network master.

The C1050 has two different means of requesting dehumidification. The first is a digital ON or OFF (differential) triac output which is activated based on a request for dehumidification. The second is a by sending a network based signal to any Proton Rooftop controller. The Proton Rooftop controller will then take the necessary steps to begin dehumidification.

In unoccupied mode, the C1050 can request that the network master restarts the fan if the humidity gets too high.



Component Identification

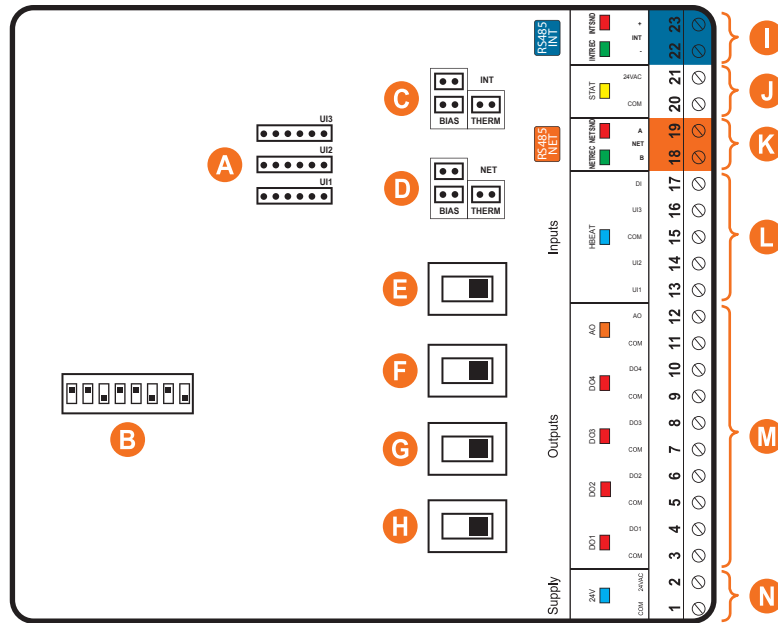

Figure 1 - Component Identification

Legend:

- A** - Analog Input Signal Mode Jumpers
- B** - Addressing dipswitch
- C** - Jumpers for terminating and bias resistors for the INT port (see **I**)
- D** - Jumpers for terminating and bias resistors for the NET port (see **K**)
- E** - SOURCE/SINK dipswitch for Output 4
- F** - SOURCE/SINK dipswitch for Output 3
- G** - SOURCE/SINK dipswitch for Output 2
- H** - SOURCE/SINK dipswitch for Output 1
- I** - INT port for RS485 communication (terminal block)
- J** - Alternate terminal blocks for 24 VAC (provides power to an optional digital sensor)
- K** - NET port for RS485 communication (terminal block)
- L** - Inputs (4 total)
- M** - Terminal Blocks for Outputs 1 to 5
- N** - Terminal Blocks for 24 VAC



LEDs

The C1050 has various LEDs which are linked to different functions and outputs of the controller. Each LED is individually identified to help the user make a quick visual diagnostic of the controller's activity and status.

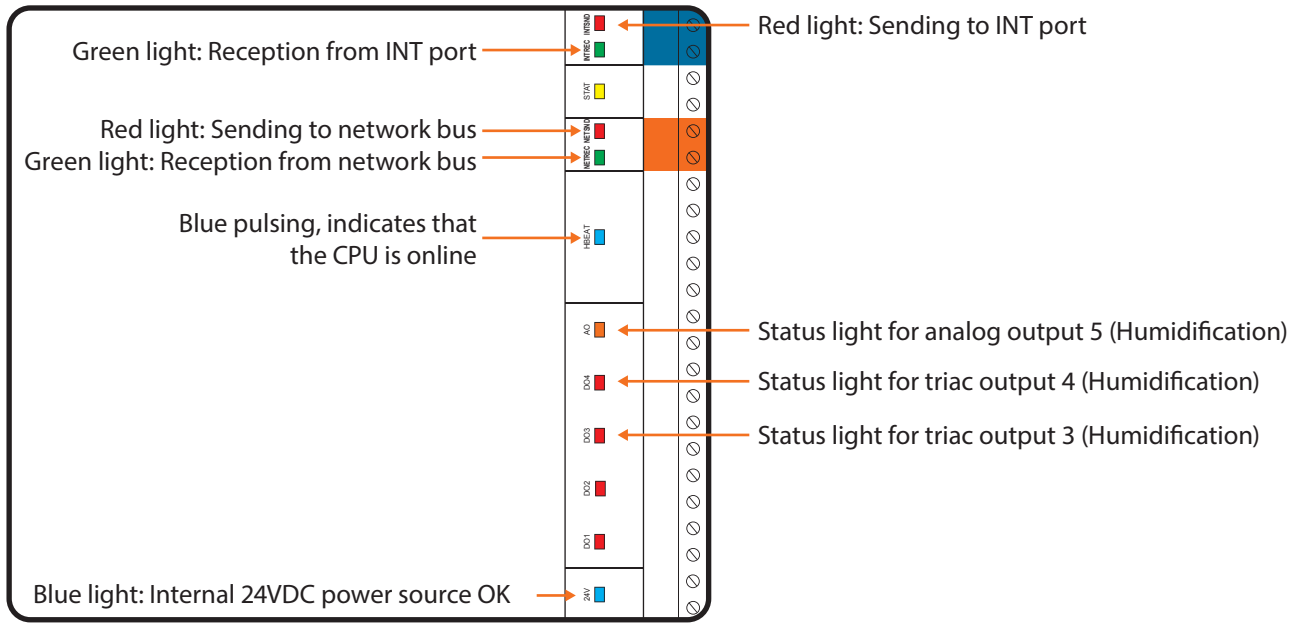

Figure 2 - LEDs Identification

Address Configuration for Networking

A unique address on each controller must be configured by setting the first 7 switches on the addressing dipswitch to the desired value.

These switches are numbered from 1 to 7 and represent a binary value from 1 to 64 (1, 2, 4, 8, 16, 32, 64 respectively). The value of each switch that is in the ON position is added together to form the numerical address of the controller.

The example on Figure 3 shows the switches 1, 2 and 4 on the ON position. So the corresponding values are 1, 2 and 8, giving an address sum of 11. ($1+2+8=11$)

The ProLon network allows a maximum of 127 addresses, therefore 127 controllers.

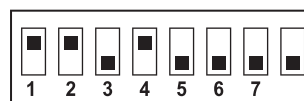

Figure 3 - Addressing Dipswitches



Input and Output Identification

All the inputs and outputs of the C1050 use pluggable screw type terminal blocks with elevator style clamping, which make connections easier and more secure.

The C1050 Humidity Controller has 2 separate communication ports offering the same functionality on each. Both act as ports for incoming Modbus communications from other Proton devices or interfaces, such as a Network Controller or remote computer with Proton Focus software.

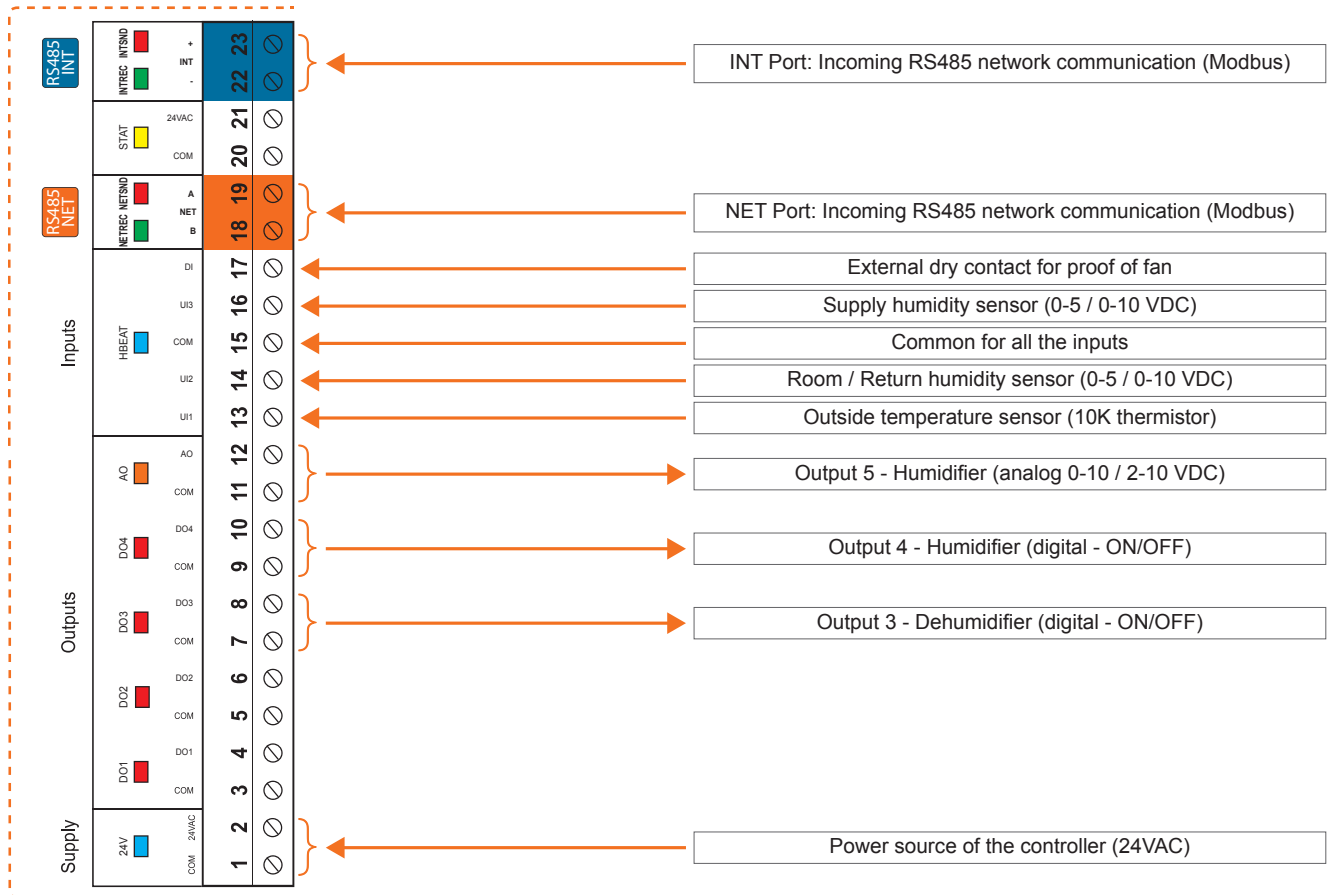

Figure 4 - Input and Output Identification



Inputs

Analog Input

The C1050 series controllers are equipped with three general purpose analog inputs. These inputs can be configured to receive signals of the following types:

- Thermistor (Ω)
- 0-5V
- 4-20mA
- 0-10V

When a thermistor is used, the thermistor must be 10K Ω TYPE 3.

Each C1050 analog input is equipped with a fast-switching barrier diode to protect against surges and short circuits.

By default, the C1050-HU analog inputs are set up for thermistor mode. The input signal mode can be changed by setting jumpers U1, U2 and U3, situated inside the casing, in the desired position:

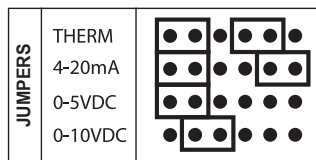

Figure 5 - Analog input

Outside Temperature Sensor

The C1050 Humidity controller has an analog input dedicated to monitoring outside air temperature and will integrate this reading into its control sequence. The sensor used is a standard 10k type 3 thermistor. If the C1050 is connected to a ProLon network, it can instead receive the outside temperature from another device on the network.

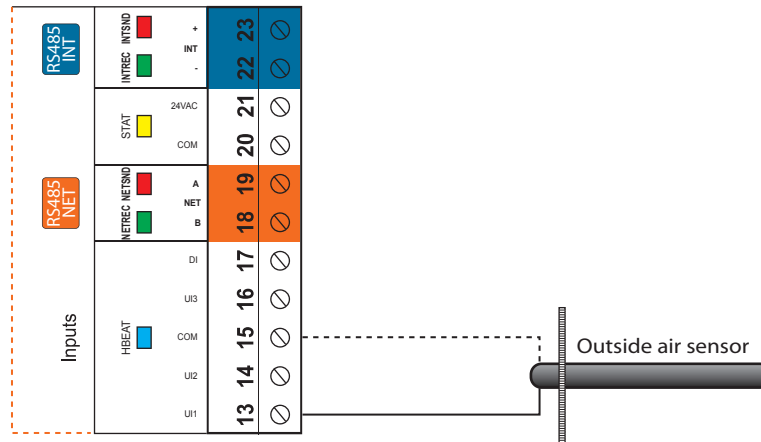

Figure 6 - Connecting the Outside Air Sensor



Relative Humidity Sensors

The C1050 Humidity controller has two inputs dedicated the relative humidity readings in the room (or return duct) and the supply (optional). This information is then integrated into its control sequences. The sensors used must provide a 0-5 or 0- 10 vVDC signal.

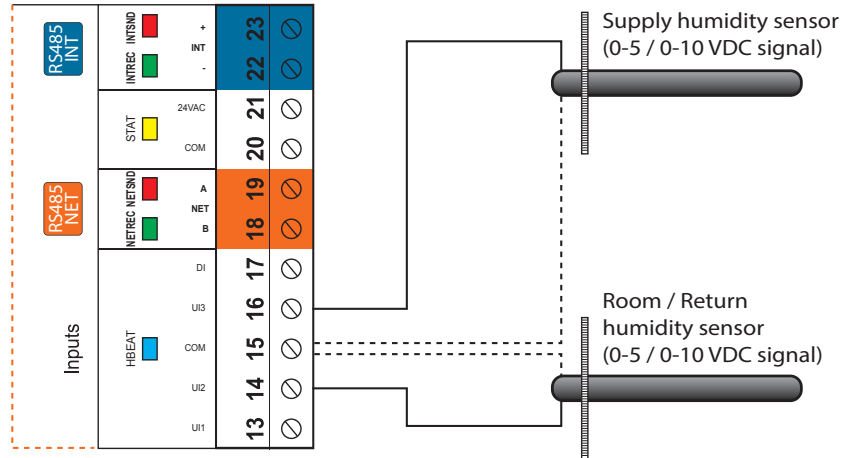

Figure 7 - Connecting the Humidity Sensors

Proof of Fan

The C1050 Humidity controller has an input dedicated for a proof of fan contact. To confirm that there is a proof of fan, the contact must be closed. If the C1050 is connected to a network, the network master can transmit the proof of fan information through the network instead. However, if no proof of fan signal is available, the dedicated input must be short-circuited to ground (terminal #15).

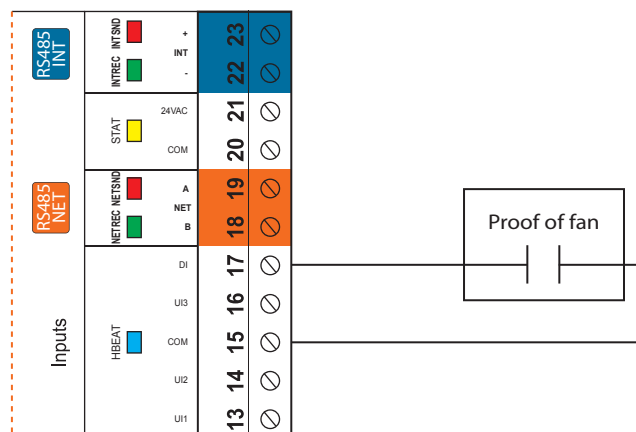

Figure 8 - Connecting the Proof of Fan



Outputs

The C1050 Humidity controller contains 3 configurable outputs. Two of the outputs are dedicated to humidification (Output 4 and Output 5). Output 4 is an ON-OFF triac output and Output 5 is an analog 0-10VDC modulating or pulsing output, which follows a proportional and integral algorithm (PI). This PI function is fully customizable via the ProLon Focus software.

The remaining output (Output 3) is dedicated to dehumidification. Output 3 is an ON-OFF triac output.

An integrated resettable fuse protects **each** of the outputs of the C1050 against current surges and short circuits. This protection will cut the current to the output as soon as an overload condition is detected. The fuse is round and yellow-colored which, upon a short circuit condition, will heat up and change to orange. When the faulty wiring or circuit is fixed, the fuse will automatically reset and allow current to flow through the output again.

Output Specifications

Output	Type	Action	Application
3	Triac Source: 24VAC MAX Current: 300 mA	On-or-Off	Dehumidification in differential mode
4	Triac Source: 24VAC MAX Current: 300 mA	On-or-Off	Humidification in differential mode
5	Configurable Analog Output: - 0 to 10 VDC - 2 to 10 VDC Max Current: 40 mA	Modulating Proportional/ Pulsed	Humidification with proportionnal and integral action

Configuration of Outputs 3 and 4

The digital triac outputs are configurable (SOURCE/SINK) via a switch located on the board. Simply move the switch to obtain either a SOURCE active output (1) or a SINK passive output (2).

1) Switch position to obtain a SOURCE **active output**:

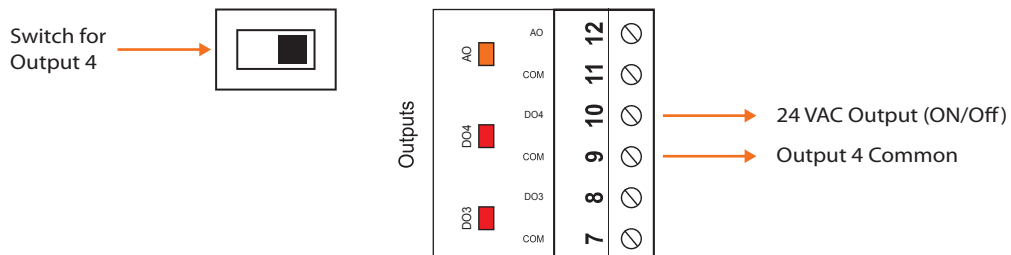

Figure 9 - Output in SOURCE mode



2) Switch position to obtain a SINK *passive output*:

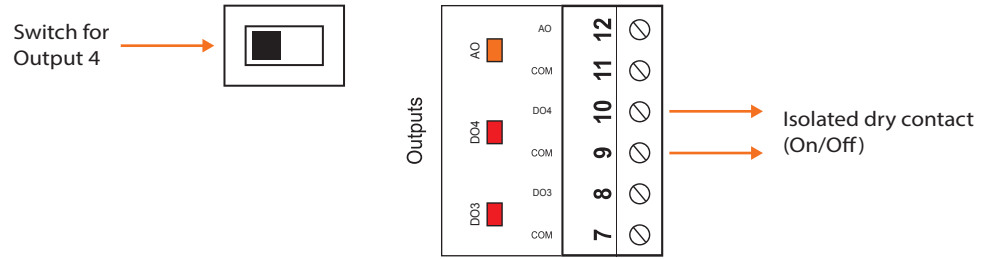

Figure 10 - Output in SINK mode

Typical Connection of the Triac Outputs 3 and 4

Two types of configurations are possible:

1) Active output (SOURCE). The C1050 is actively powering the load:

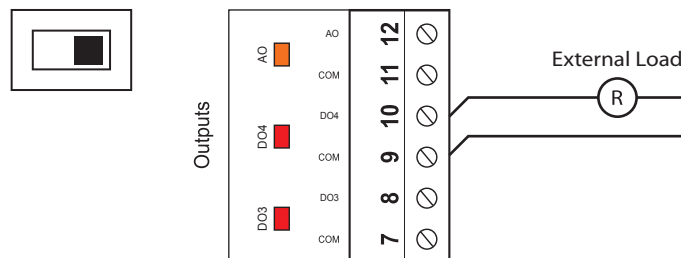

Figure 11 - Connection of Active Outputs 3 and 4

2) Passive output (SINK). The C1050 opens and closes a contact to allow an external source to power the load:

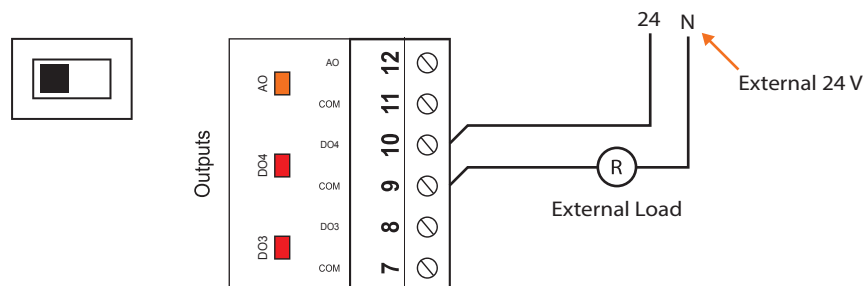

Figure 12 - Connection of Passive Outputs 3 and 4



Typical Connection of the Analog Output

Two types of configuration are possible:

- 1) The C1050 powers the load and provides a control signal:

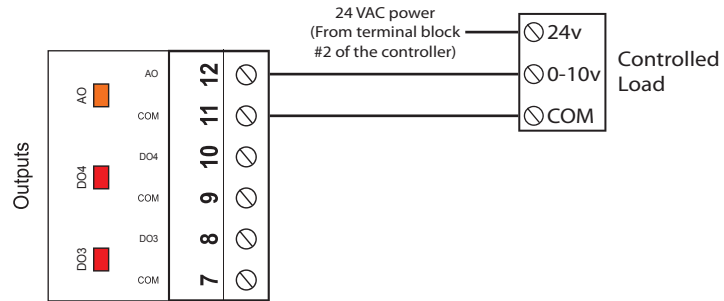

Figure 13 - Connecting the Analog Output (Controller Powered)

- 2) The C1050 only provides the control signal to the load, which is powered by an external source:

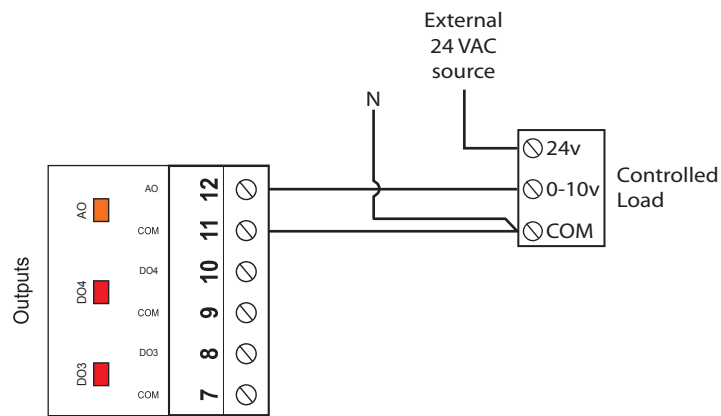

Figure 14 - Connecting the Analog Output (External Power)



Power Source

The Proton C1050 controller is powered by a 24 VAC power source connected using the "COM" terminal and the "24 VAC" terminal. The common for all inputs and outputs are the same as the power source's common (exception: when an output is set to passive, the common for this output will not correspond to the power source common). All output power sources also originate from the controller's power source.

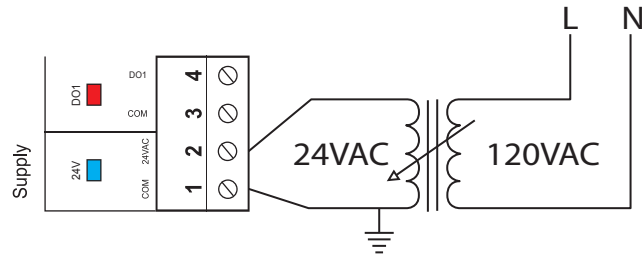

Figure 15 - Connecting the 24VAC Power Source

Network Communication

The Proton C1050 controller works autonomously or networked. When networked, it will communicate in real-time with other controllers. The C1050 controller's default communication protocol is Modbus RTU over RS485. The addressing is done with the addressing dipswitch located on the C1050 card (see Figure 3). The network connections are made using the NET terminal block located on the Proton C1050 controller.

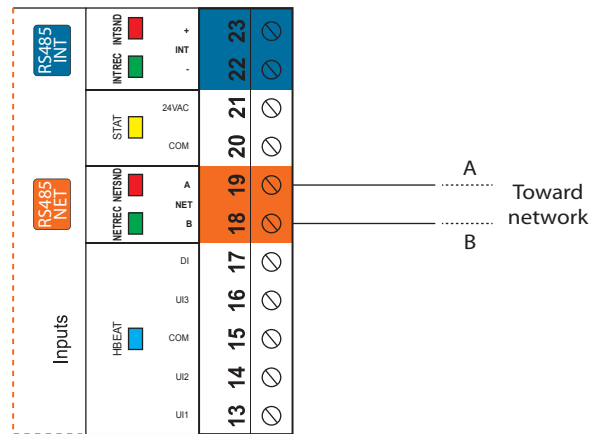

Figure 16 - Connecting to the Network



Technical Specifications

Supply: 24 VAC \pm 10%, 50/60 Hz, Class 2

Consumption: 2 VA (Consumption), 32 VA (Input)

Inputs:

- Outside air – thermistor 10K
- Return/room humidity – 0-5 / 0-10 VDC
- Supply humidity – 0-5 / 0-10 VDC
- Proof of fan – dry contact

Digital outputs: 2 triac outputs, 10-30 VAC source or sink, 300 mA max (resettable fuse)

Analog output: 1 output 0-10 VDC / 2-10 VDC, 40 mA max (resettable fuse)

Indication lights (LED): State of each output / Communication / Power / State of microprocessor

Microprocessor: PIC18F6722, 8 bits, 40 MHz, 128KB FLASH memory

Casing: Molded ABS, UL94-HB

Communication: Modbus RTU (RS485), up to 127 nodes

Baud rate: 9600, 19200, 38400, 57600, 76800, 115200

Connection: Removable screw-type terminal blocks (16 AWG max)

Dimensions: 6.5" x 5.3" (165mm x 135mm)

Weight: 0.85 lbs (0.4 kg)

Environment: -4 to 122 °F (-20 to 50 °C) Non-Condensing

Certification: UL916 Energy Management Equipment, CAN/CSA-C22.2, RoHS, FCC part 15: 2012 class B

The performance specifications are nominal and conform to acceptable industry standards. Prolon Inc. will not be liable for damages resulting from misapplication or misuse of its products.



Compliance

- FCC Compliant to CFR47, Part 15, Subpart B, Class B
- Industry Canada (IC) Compliant to ICES-003, Issue 5: CAN ICES-3 (B)/NMB-3(B)
- RoHS Directive (2002/95/EC)

FCC User Information

This device complies with Part 15 of the FCC Rules. Operation is subject to the following two conditions: (1) this device may not cause harmful interference, and (2) this device must accept any interference received, including interference that may cause undesired operation.

Caution: Any changes or modifications not approved by Prolon can void the user's authority to operate the equipment.

Note: This equipment has been tested and found to comply with the limits for a Class B digital device, pursuant to part 15 of the FCC Rules. These limits are designed to provide reasonable protection against harmful interference in a residential installation. This equipment generates, uses and can radiate radio frequency energy and, if not installed and used in accordance with the instructions, may cause harmful interference to radio communications. However, there is no guarantee that interference will not occur in a particular installation. If this equipment does cause harmful interference to radio or television reception, which can be determined by turning the equipment off and on, the user is encouraged to try to correct the interference by one or more of the following measures:

- Reorient or relocate the receiving antenna.
- Increase the separation between the equipment and receiver.
- Connect the equipment into an outlet on a circuit different from that to which the receiver is connected.
- Consult the dealer or an experienced radio/TV technician for help.

Industry Canada

This Class (B) digital apparatus meets all the requirements of the Canadian Interference-Causing Equipment regulations.

Cet appareil numérique de la Classe (B) respecte toutes les exigences du Règlement sur le matériel brouilleur du Canada.



Overall Dimensions

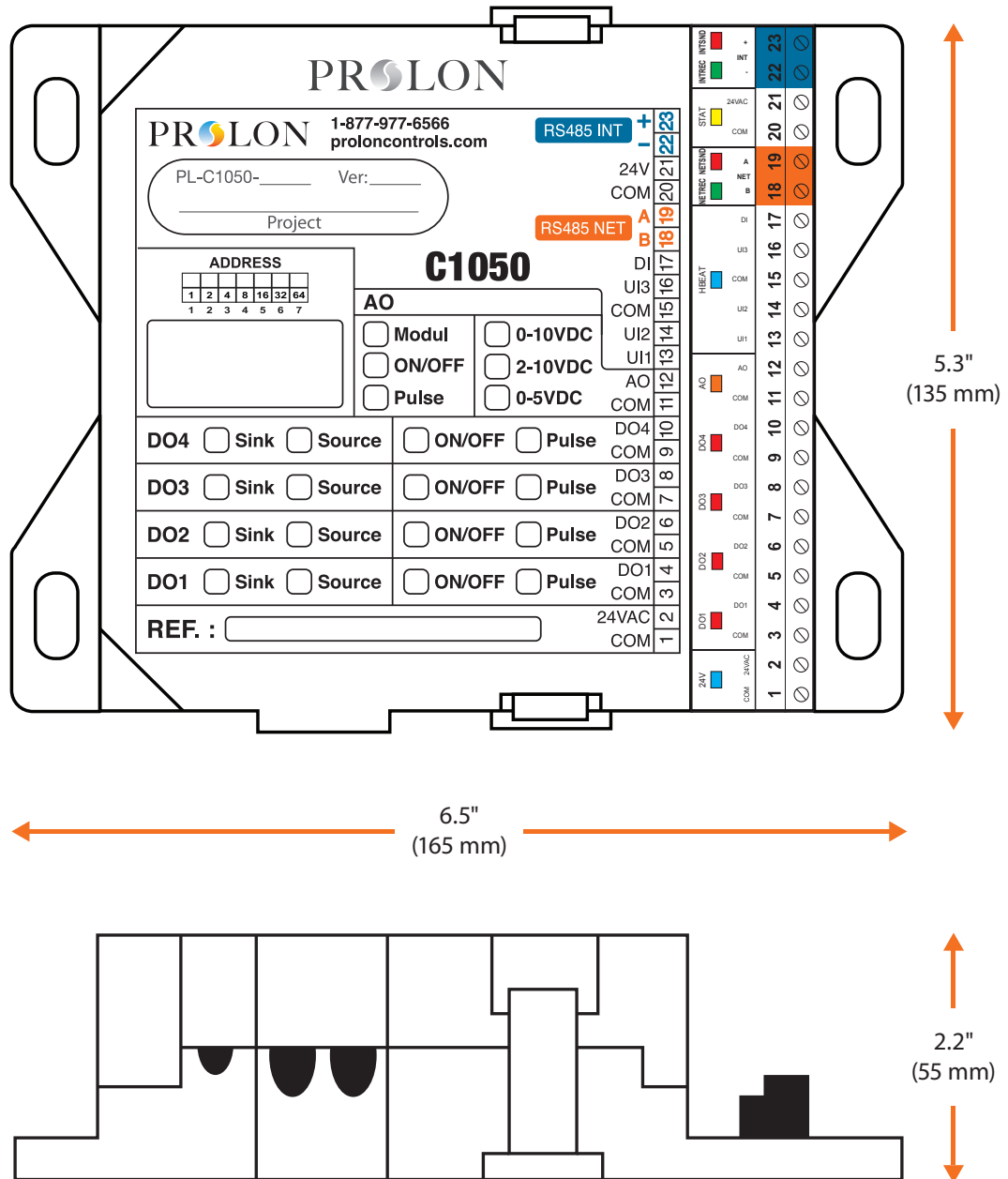

Figure 17 - C1050 Size Diagram

REV. 7.3.1

PL-HRDW-HU-C1050-C/F-EN

© Copyright 2021 Prolon. All rights reserved.

No part of this document may be photocopied or reproduced by any means, or translated to another language without prior written consent of Prolon. All specifications are nominal and may change as design improvements are introduced. Prolon shall not be liable for damages resulting from misapplication or misuse of its products. All trademarks are the property of their respective owners.