



HARDWARE GUIDE

Digital Sensor - T1000 Series

Specifications and Operational Guide

www.proloncontrols.com | info@proloncontrols.com
17 510, rue Charles, Suite 100, Mirabel, QC, J7J 1X9



Table of Contents

General Information.....	4
Description.....	4
Part Number Selection	4
Installation	5
Power and Communication.....	6
Auxiliary Analog Input	6
Operation.....	7
Hint Display.....	7
Changing the Setpoint.....	8
Schedule Override	8
Navigating Menus.....	9
Menu Structure	10
T1000 Options and Visualisation Menus.....	10
VAV Controller: Visualisation Displays.....	11
VAV Controller: Configuration Menus (Top Level)	11
VAV Controller: Configuration Menus - Temperature.....	12
VAV Controller: Configuration Menus - Damper	12
VAV Controller: Configuration Menus - Pressure.....	13
VAV Controller: Configuration Menus - Outputs.....	13
VAV Controller: Configuration Menus - Radiant Floor.....	14
VAV Controller: Configuration Menus - Other	14
VAV Controller: Configuration Menus - Calibration.....	15
VAV Controller: Configuration Menus - Network	16
Technical Specifications.....	17
Compliance.....	18
FCC User Information	18
Industry Canada	18
Overall Dimensions.....	19



Table of Figures

Figure 1 - Opening Tab.....	5
Figure 2 - Terminal Block Pinout	5
Figure 3 - Terminal Block	6
Figure 4 - RJ45 Pinout.....	6
Figure 5 - Remote Temp Sensor	6
Figure 6 - Averaging multiple remote sensors (Series-Parallel).....	6
Figure 7 - Averaging multiple remote sensors (Parallel-Series).....	6
Figure 8 - Touch Pad Controls.....	7
Figure 9 - Touch Pad Feedback	7
Figure 10 - Touch Pad Hint.....	7
Figure 11 - T1000 Size Diagram	19



General Information

Description

The T1000 digital sensors are designed for operation in conjunction with the ProLon VAV or HPS controllers, to which they provide zone temperature, setpoint and occupancy override information.

The T1000 digital sensors also provide an access point from which to visualize and configure any parameter on the connected VAV controller through an on-screen menu system.

The T1000 features a circular capacitive touch pad, graphic LCD screen with backlighting and an auxiliary analog input.



Part Number Selection

PL-T1000-WGL

Casing Color:
W = White
B = Black

Label Color
GL = Grey Label
WL = White Label





Installation

1. Open casing to remove back cover by pushing on the tab located underneath the thermostat. (Figure 1)
2. Pull wire(s) through central hole of back cover.
3. Screw in the back cover to the wall.
4. Connect wires:
 - If using twisted pair wires:
 - Pull out the screw terminal blocks.
 - Remove 1 cm insulation from the end of each wire.
 - Connect the wires to the terminal blocks and re-connect the terminal blocks. (Figure 2)
 - If using CAT5 cable:
 - Plug the cable into the RJ45 jack of the T1000 (if CAT5 cable is opened at the controller, refer to Figure 4 for pinout of the T1000's RJ45 jack).
5. Reconnect top cover.

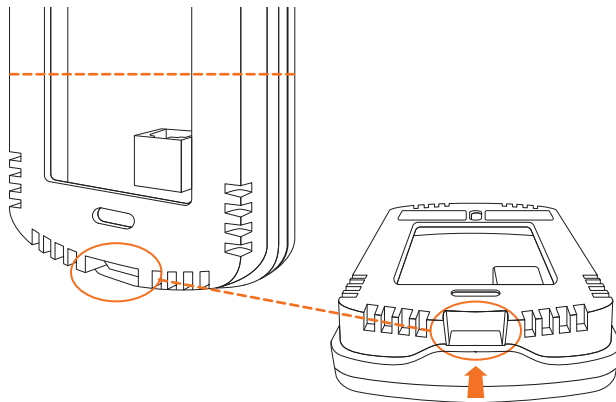

Figure 1 - Opening Tab

□	⊗	1	INT +
□	⊗	2	INT -
□	⊗	3	24 VAC
□	⊗	4	COM
□	⊗	5	
□	⊗	6	
□	⊗	7	
□	⊗	8	
□	⊗	9	AUX IN
□	⊗	10	COM

Figure 2 - Terminal Block Pinout

IMPORTANT: Do not install the thermostat under the following conditions:

- Any location exposed to direct sunlight
- On an outside wall
- Near an air discharge grill
- In a location where vertical air circulation is restricted
- Near a dimmer switch



Power and Communication

The T1000 is typically powered by the same controller it is communicating with. It has two different connector types available for your choice of preferred wiring method.

- The first is a 4-pin, screw-type terminal block suitable for a 4 wire connection
- The second is an RJ45 connector intended for standard CAT5 cable

Through either of these connection methods, the T1000 is powered (24 VAC Class 2) and communicates over Modbus RTU (RS485, 57600 bps) as a Modbus Master.

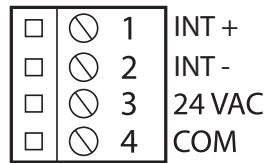

Figure 3 - Terminal Block

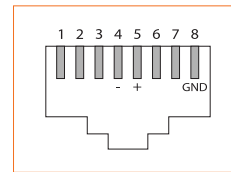

Figure 4 - RJ45 Pinout

Auxiliary Analog Input

The T1000 has an auxiliary analog input which can be used to connect another thermistor. The T1000 can be configured to use this alternate temperature reading for a variety of functions, including temperature averaging or radiant floor slab temperature. The alternate thermistor (10KΩ type 3) can be connected to the auxiliary input using the "AUX IN" and "COM" pins.

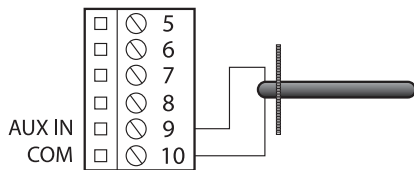

Figure 5 - Remote Temp Sensor

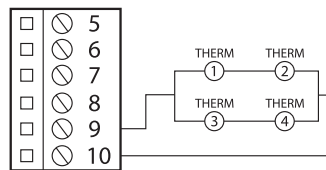

Figure 6 - Averaging multiple remote sensors (Series-Parallel)

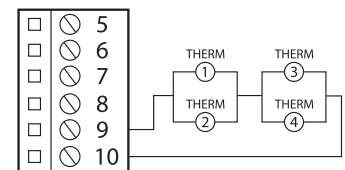

Figure 7 - Averaging multiple remote sensors (Parallel-Series)

Case #1 Remote sensor only

Physical connection: connect remote sensor (10KΩ type 3) into terminals 9 and 10 (see figure 5)
T1000 configuration: set T1000 analog input to "Aux Only"

Case #2 Averaging 2 sensors (1x remote, 1x internal)

Physical connection: connect remote sensor (10KΩ type 3) into terminals 9 and 10 (see figure 5)
T1000 configuration: set T1000 analog input to "Average"

Case #3 Averaging 4 sensors (4x remote)

Physical connection: connect 4 sensors (10KΩ type 3) in Series-Parallel configuration (see figure 6) or in Parallel-Series configuration (see figure 7) to terminals 9 and 10
T1000 configuration: set T1000 analog input to "Aux Only"



Operation

The T1000 is controlled using the circular touch pad on the bottom half of the thermostat. The touch pad uses capacitive sensing technology to detect finger proximity. There are no moving parts to push or rotate. The T1000 is controlled using simple scrolling, tapping or holding motions, performed around the circle of the touch pad. The center of the circle is unused.

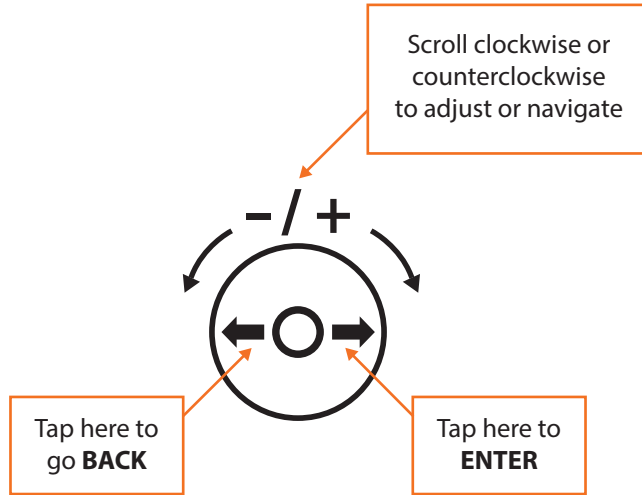

Figure 8 - Touch Pad Controls

Hint Display

At the bottom of the screen, a circle representing the touch pad is displayed, with hints on how to navigate and modify settings, as well as providing feedback as you manipulate the touch pad. Hints are context-sensitive and will only display where logical.

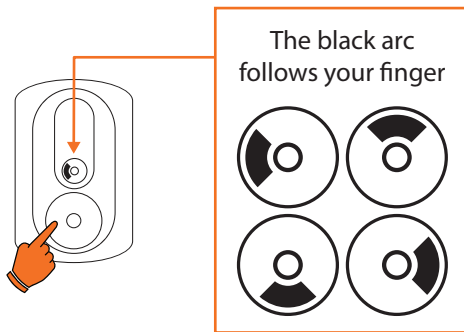

Figure 9 - Touch Pad Feedback



Figure 10 - Touch Pad Hint



Changing the Setpoint

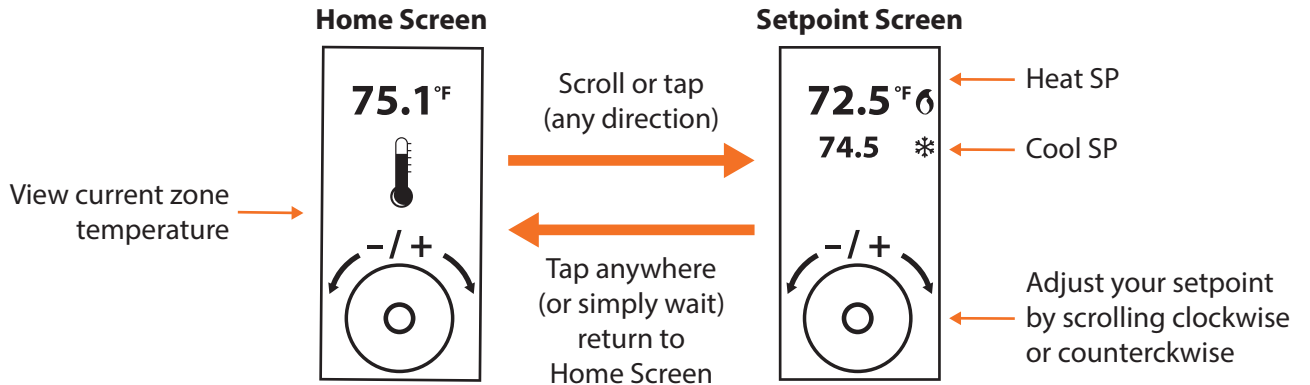

Schedule Override

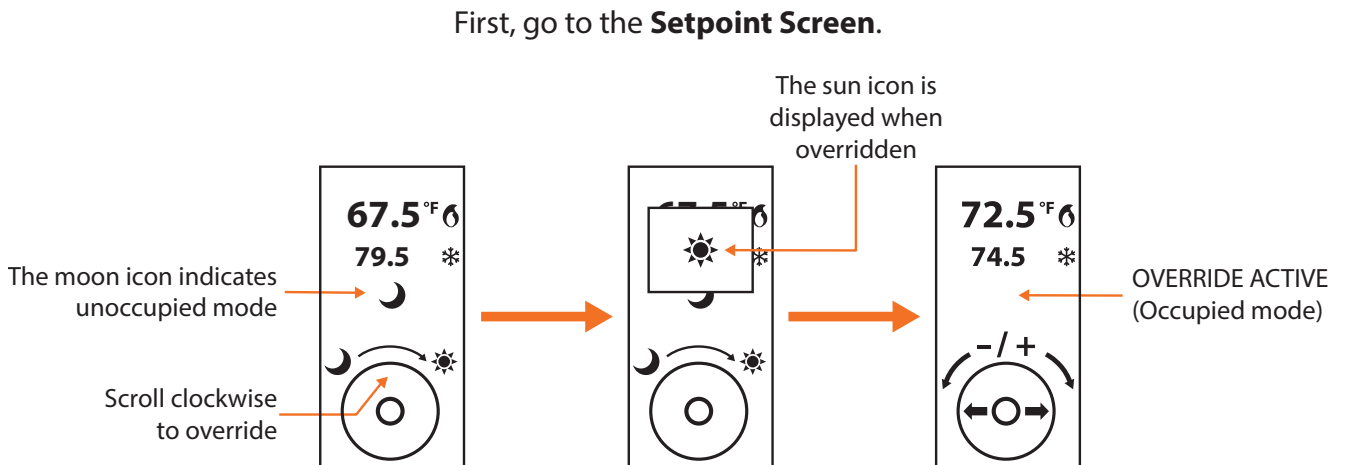



Navigating Menus

From the **Home Screen**.

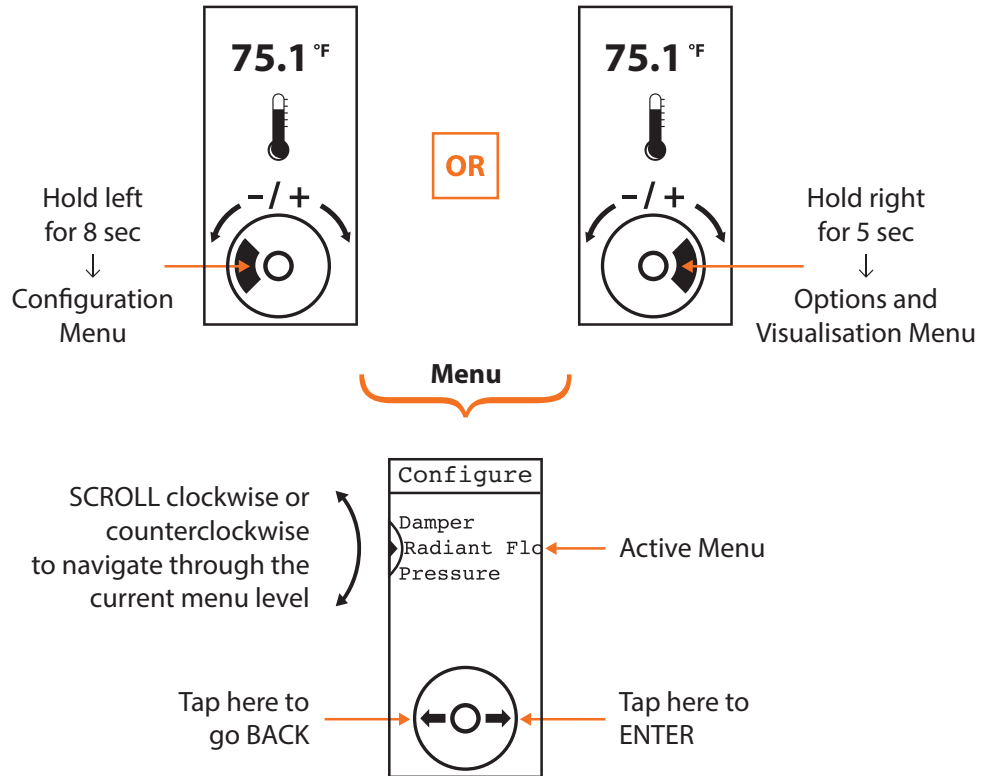



Menu Structure

The T1000 has two menu systems: The first is dedicated to the general options of the T1000 thermostat as well as visualization of the status of the controller to which it is connected. The second menu system is dedicated entirely to the configuration settings of the controller to which it is connected. These menu structures are outlined below.

T1000 Options and Visualisation Menus

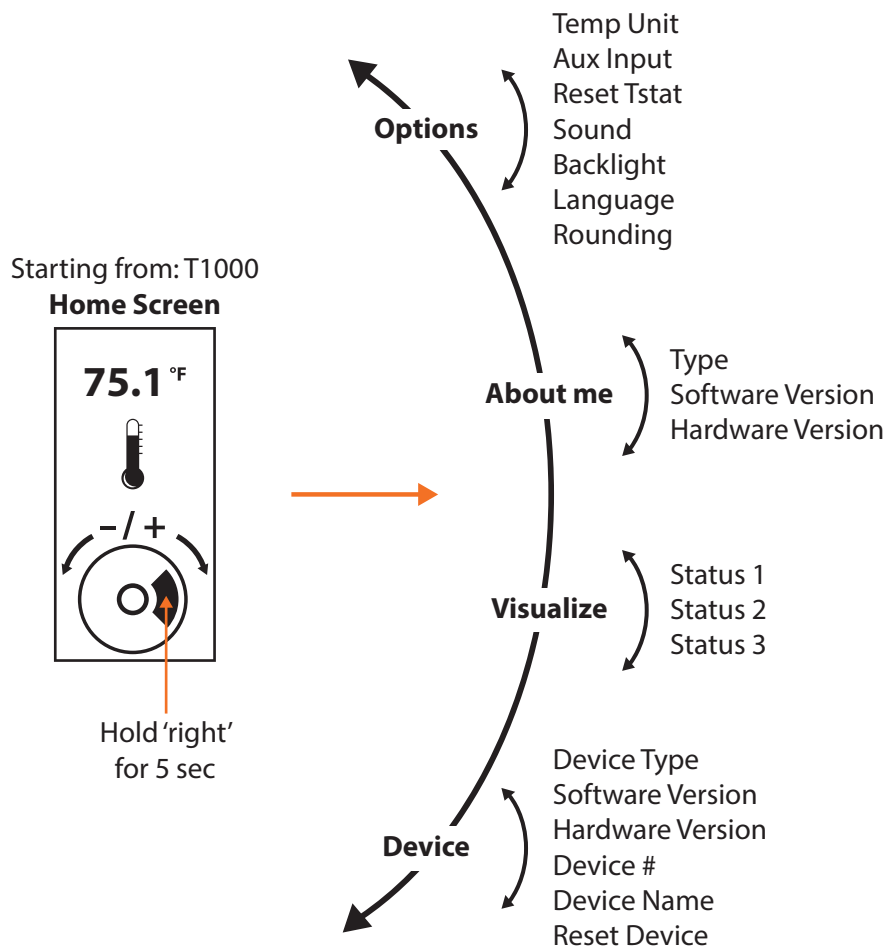



VAV Controller: Visualisation Displays

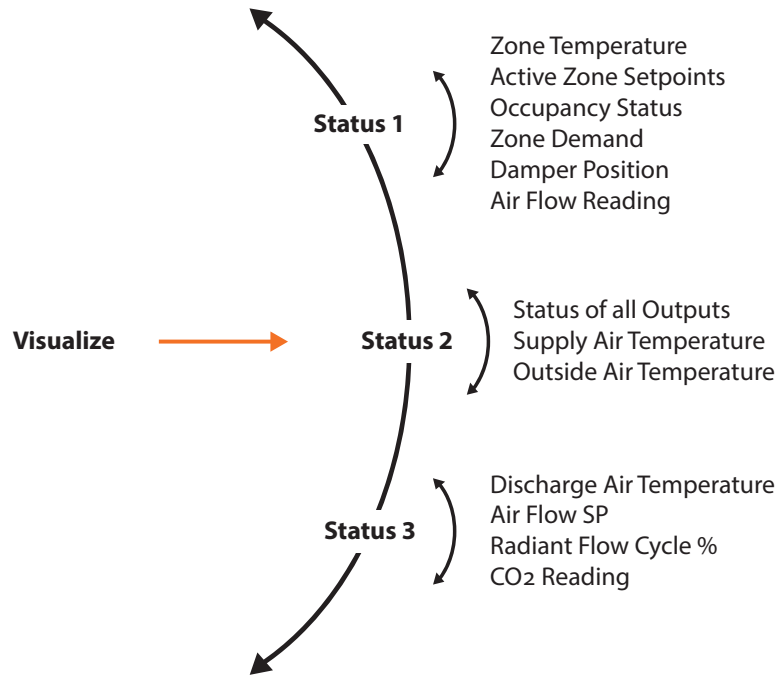

VAV Controller: Configuration Menus (Top Level)

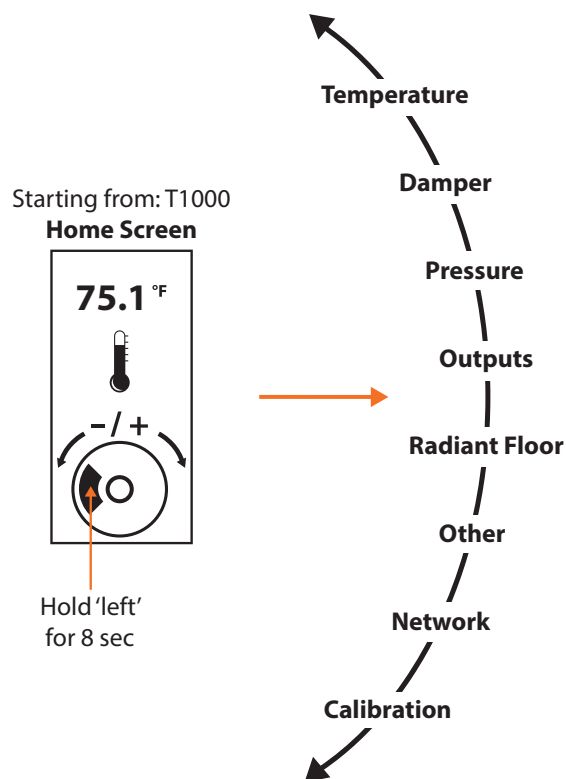



VAV Controller: Configuration Menus - Temperature

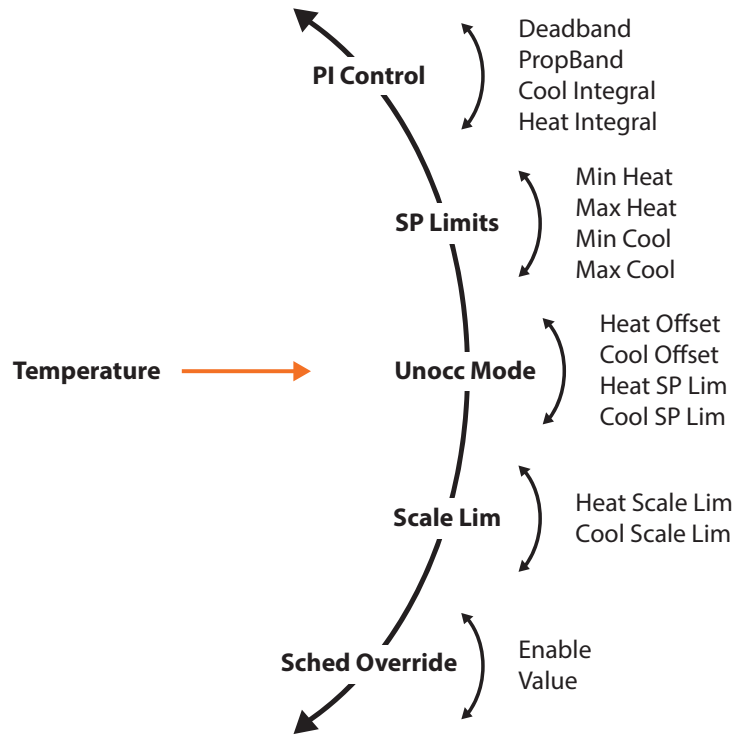

VAV Controller: Configuration Menus - Damper

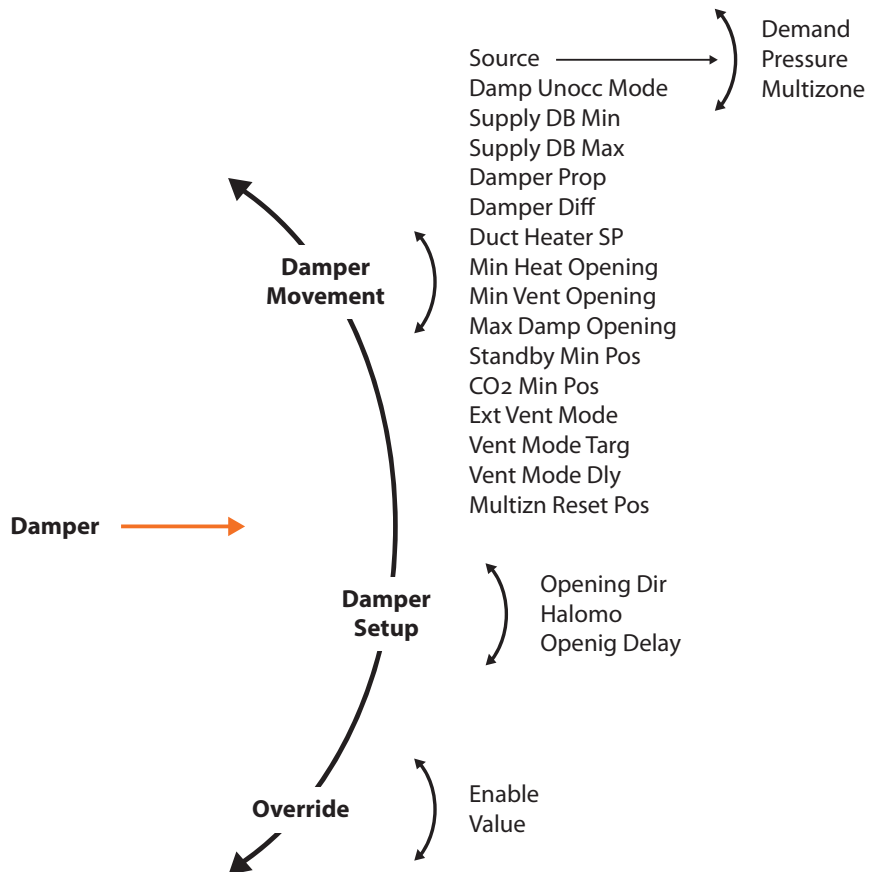



VAV Controller: Configuration Menus - Pressure

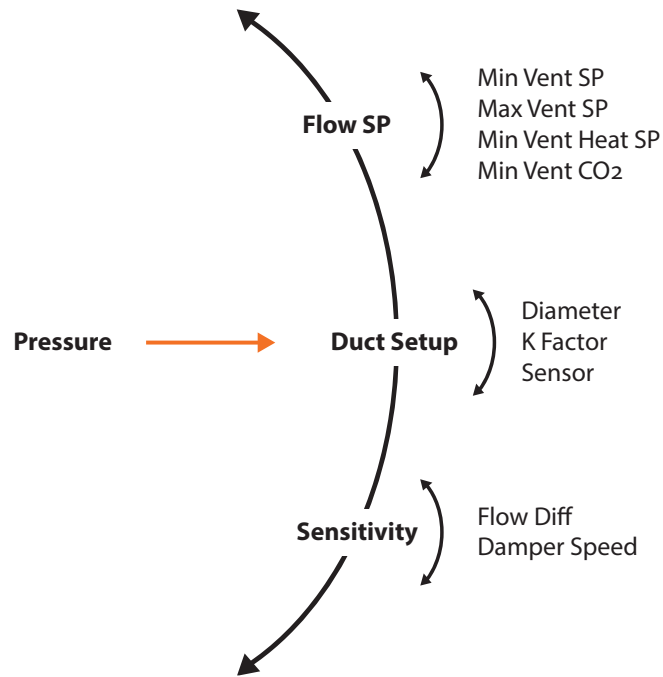

VAV Controller: Configuration Menus - Outputs

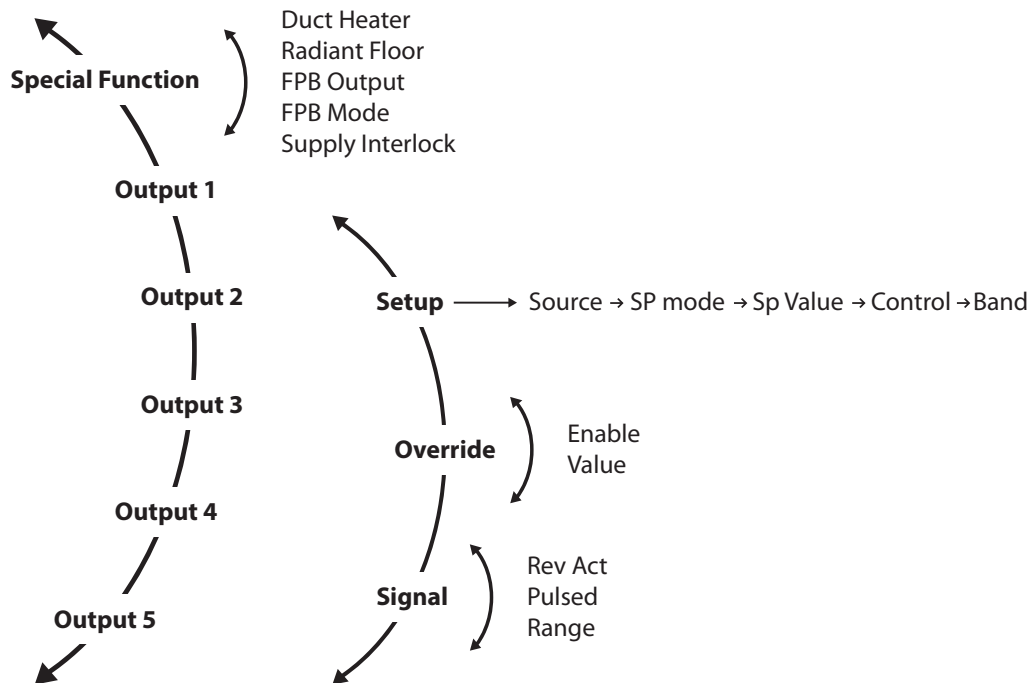



VAV Controller: Configuration Menus - Radiant Floor

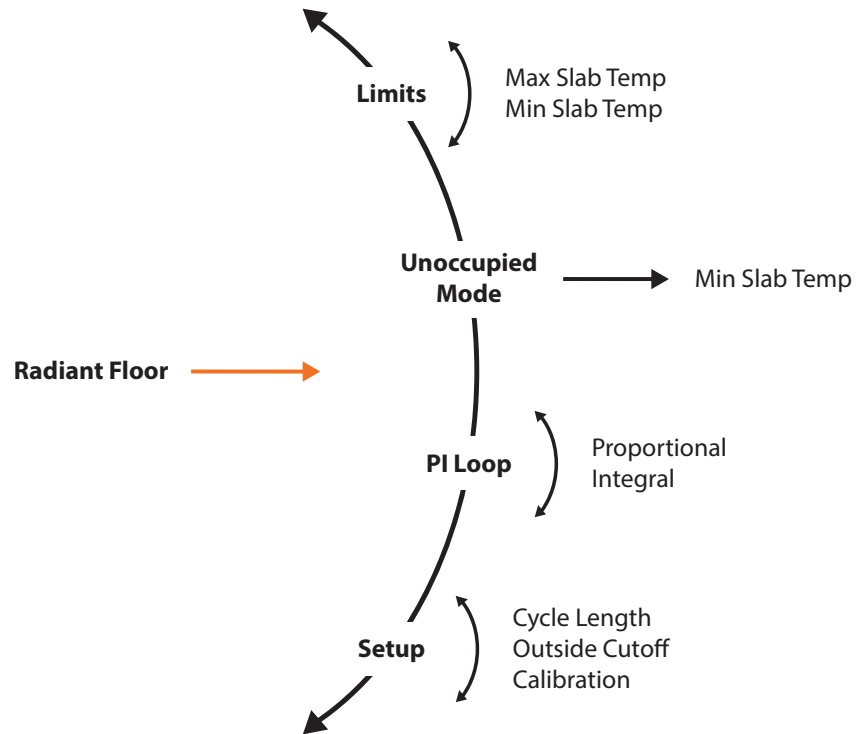

VAV Controller: Configuration Menus - Other

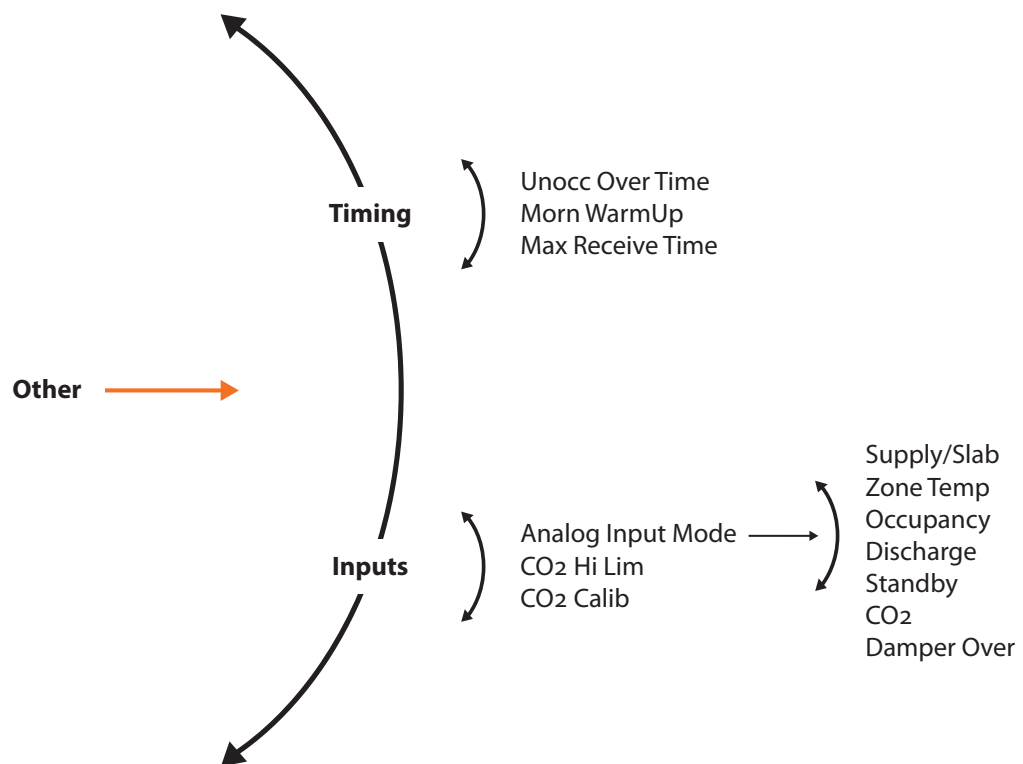



VAV Controller: Configuration Menus - Calibration

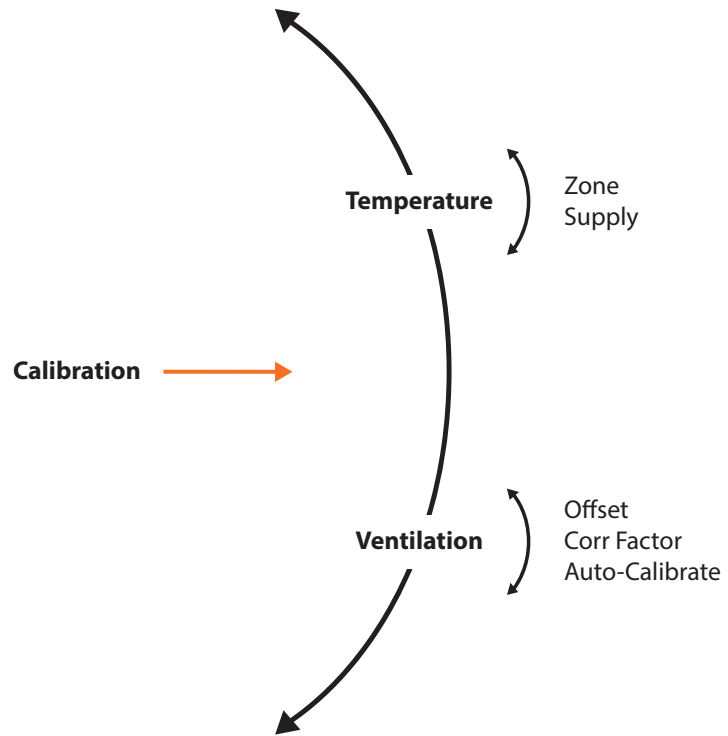



VAV Controller: Configuration Menus - Network

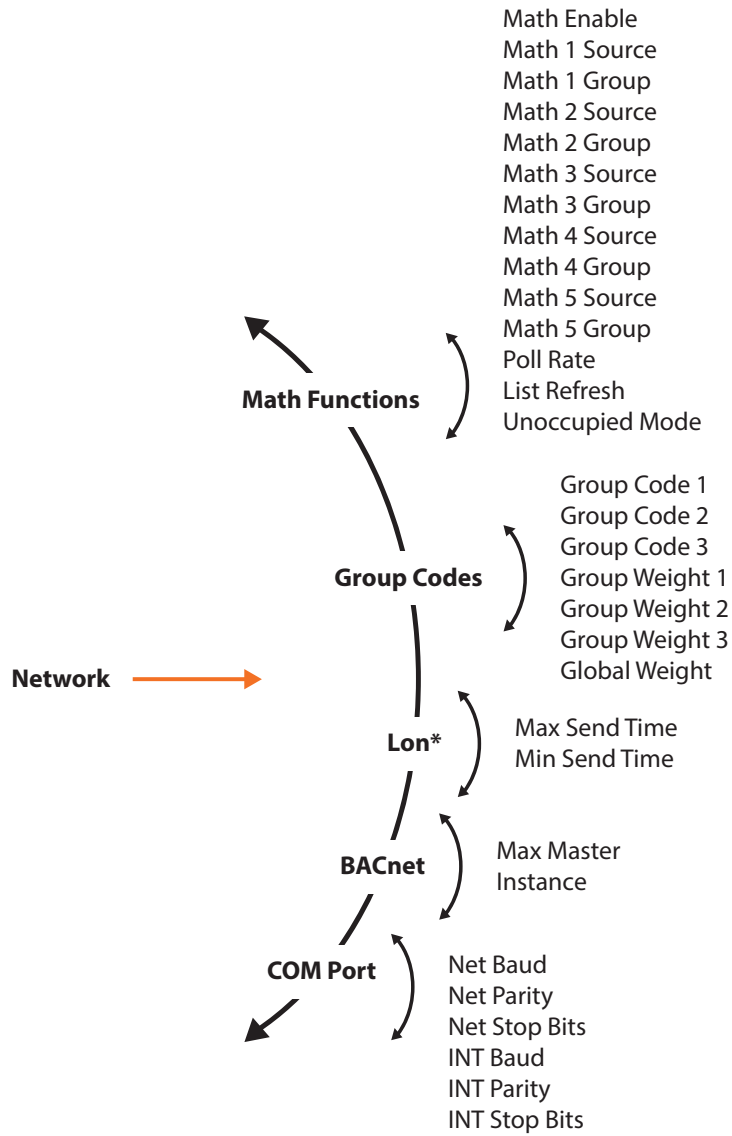

**Available only with a C1050.*



Technical Specifications

Supply: 24 VAC \pm 10%, 50/60 Hz, Class 2

Power Consumption: 5 VA max

Inputs: 1 analog input (Thermistor 10K type3), 10 bit resolution

Outputs: None

Screen: LCD 80x130 pixels with backlighting

Interface: Circular capacitive touch pad

Sound: Audible feedback during user interactions

Microprocessor: Atmel 32 bits, 60 MHz, 256K bytes Flash memory

Connection: Screw-type terminal blocks (16 AWG max) and RJ45 modular jack

Dimensions: 3.23" x 4.96" x 1" (82 mm x 126 mm x 25 mm)

Weight: 0.5 lbs (0.23 kg)

Environment: 32-122 °F (0-50 °C)

Mounting: Standard electrical box 2" x 4"

Certification: FCC Part 15: 2012 class B

The performance specifications are nominal and conform to acceptable industry standards. Prolon Inc. will not be liable for damages resulting from misapplication or misuse of its products.



Compliance

- FCC Compliant to CFR47, Part 15, Subpart B, Class B
- Industry Canada (IC) Compliant to ICES-003, Issue 5: CAN ICES-3 (B)/NMB-3(B)
- RoHS Directive (2002/95/EC)

FCC User Information

This device complies with Part 15 of the FCC Rules. Operation is subject to the following two conditions: (1) this device may not cause harmful interference, and (2) this device must accept any interference received, including interference that may cause undesired operation.

Caution: Any changes or modifications not approved by Proton can void the user's authority to operate the equipment.

Note: This equipment has been tested and found to comply with the limits for a Class B digital device, pursuant to part 15 of the FCC Rules. These limits are designed to provide reasonable protection against harmful interference in a residential installation. This equipment generates, uses and can radiate radio frequency energy and, if not installed and used in accordance with the instructions, may cause harmful interference to radio communications. However, there is no guarantee that interference will not occur in a particular installation. If this equipment does cause harmful interference to radio or television reception, which can be determined by turning the equipment off and on, the user is encouraged to try to correct the interference by one or more of the following measures:

- Reorient or relocate the receiving antenna.
- Increase the separation between the equipment and receiver.
- Connect the equipment into an outlet on a circuit different from that to which the receiver is connected.
- Consult the dealer or an experienced radio/TV technician for help.

Industry Canada

This Class (B) digital apparatus meets all the requirements of the Canadian Interference-Causing Equipment regulations.

Cet appareil numérique de la Classe (B) respecte toutes les exigences du Règlement sur le matériel brouilleur du Canada.



Overall Dimensions

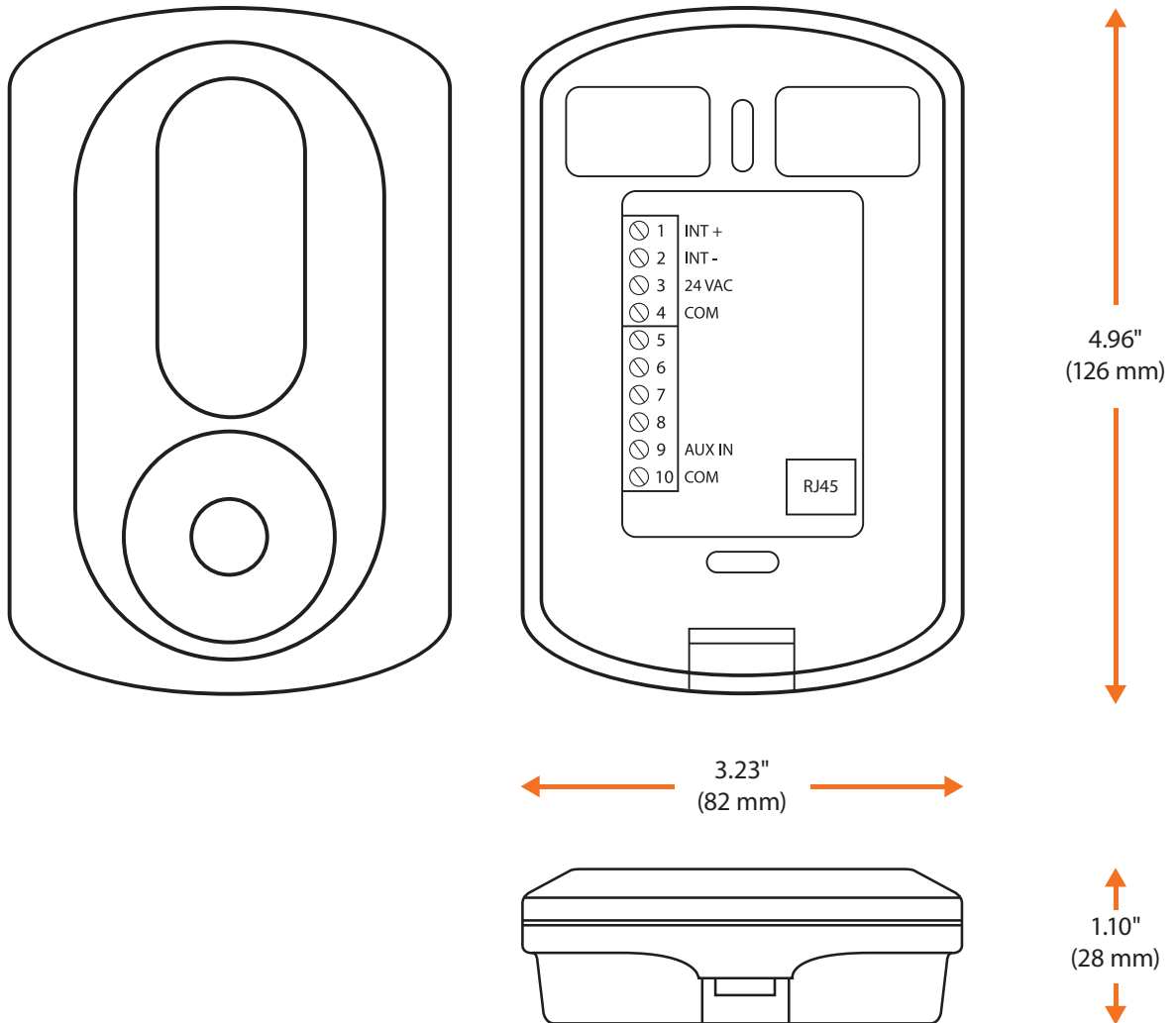

Figure 11 - T1000 Size Diagram

REV. 7.3.1

PL-HRDW-T1000-F-EN

© Copyright 2023 Prolon. All rights reserved.

No part of this document may be photocopied or reproduced by any means, or translated to another language without prior written consent of Prolon. All specifications are nominal and may change as design improvements are introduced. Prolon shall not be liable for damages resulting from misapplication or misuse of its products. All trademarks are the property of their respective owners.